



VIPER 4 TOOL SERVICE MANUAL



**SEMI-AUTOMATIC, LOW VELOCITY
PISTON TYPE FASTENING TOOL**

The Model VIPER 4 troubleshooting/service manual has been developed to assist ITW CCNA field sales and distributor field/service personnel in servicing the VIPER 4 powder actuated tool. This manual is designed to reduce the amount of tool down time when a problem occurs by giving field and service personnel troubleshooting techniques and the proper corrective measures to take. In many cases, servicing can be done right at the job site in a very short time. This manual can also be used as an educational tool for teaching perspective operators and service personnel on the inner workings of the tool and proper service techniques. Using this manual wisely will reduce tool down time, promote customer confidence and allow more quality time for selling.

This manual is broken into 4 chapters with 3 sections on tool disassembly / assembly:

1. Introduction
2. Troubleshooting
3. Tool Disassembly
 - a. Front End
 - b. Advance Lever / Advance Pin Holder
 - c. Firing Pin/Backend
4. Tool Schematic

When troubleshooting or servicing a tool it is important to understand the function of each component. Knowing the function of each component will quickly lead to the troubled area. It is also important to be able to accurately describe a condition using the correct terminology.

When troubleshooting or servicing a tool it is always important to function test the tool first. **Always check the tool first to make sure that it does not contain a live load.** Test the tool several times by depressing the muzzle bushing fully on a hard overhead surface such as a door jamb and actuate the tool via the trigger sleeve on the pole. You should hear an audible click as the firing pin releases. Let up on the tool and check to be sure the barrel has opened to the full open position. This function test may lead you to the proper area of the tool needing service.

When attempting any repair on a Ramset tool, be certain you have read and understand the operator's manual, you have the correct tools to perform the repair, and have/wear the correct personal protective equipment for the circumstance.

There may be cases where this manual may not supply the information needed, or the user may need additional information. For further information the ITW Tool Repair Center or Ramset Technical Service can be contacted.

Further information on obtaining parts can be found at www.itwconstructionparts.com

The troubleshooting section is intended to direct the user or repair technician to some of the more probable occurrences that may exist in the tool. It does not list all possible occurrences. To master the repair of any tool you must first know and understand how each part functions. The basic symptoms, probable causes and solutions are listed below.

The leading cause of Viper tool malfunction is operator error. The Viper tool is a push-push tool. The front end is guided to the ceiling, the barrel is compressed closed, then the trigger sleeve on the pole is slid upward actuating the tool. Most problems come into play when the operator tries to fire the tool with ONE quick or forceful motion. Symptoms of this show on the strip load where many shots are missed.

Tool stuck in closed position and piston tip at end or protruding from the tool.

- Cause – tool was overdriven or debris caught in front end
 1. Inspect Front end components for damage/debris
 2. Replace Buffer Assembly

Tool lacks power, may experience “poof” or “dud” loads, or fastener stand-off

- Cause – piston not fully returning or dropping before taking a shot
 1. Clean Piston and Barrel Assembly
 2. Inspect pawls, rotate direction or replace
 3. Inspect piston for wear or damage

Tool clicks or fires once and next load **does not** advance

- Cause – Check advance lever or advance pin holder assembly
 1. If load strip does not move at all, replace advance lever assembly

Tool skips powder loads

1. Cause – Tool front end is not fully compressed before the trigger sleeve is actuated.
2. The front end must be fully compressed before the trigger sleeve is actuated. Push-Push, two step motion

Depress tool, tool does not click and load does not fire

- Is the barrel fully closing? If No
 1. Missing Stop Ball in Rear Collar
 2. Barrel installed backward
 3. Collar not threaded all the way
 4. Pawls incorrectly positioned behind piston
 5. Debris in receiver or around barrel
 6. Cocking rod loose/damaged
- Incorrect or damaged pole tool

The result of a problem in the front barrel assembly is inconsistent fastenings or premature damage to any of the component parts. The front barrel assembly is the simplest part of the tool to service and maintain; however it does require the greatest amount of servicing. Ramset recommends cleaning the front barrel assembly after each days use. This section will provide a guide to evaluating problems, taking corrective actions and prevent further problems.

Inconsistent Fastenings

Inconsistent fastenings are caused by variations in the chamber volume from shot to shot. Simply put, the piston does not fully return after each shot. The level of inconsistency can vary from a “poof load” or “dud shot” to variations in fastener penetration.

In the VIPER 4 piston reset is accomplished with the pawls and gravity causes the piston to return to its home position when the tool is pointed overhead. Inconsistent fastening is likely to be caused by dirt and debris preventing the piston from falling back into position. Damage to the pawls may also be a contributing factor. The pictures on the following pages show how to disassemble the front end and diagnose the components.

Damage to Front End Components

When a tool is in need of service with damaged front end components, there is not much troubleshooting involved. The problem is obvious, broken parts. It is important to understand what caused the failure and what to do to prevent the damage from happening again. This damage is likely caused due to misapplication or misuse of the tool. The pictures on the following pages show how to disassemble the front end components. Function testing the tool before and after servicing the tool will help diagnose the issue and can assure the problem is corrected. Instructions on tool function testing can be found in the operator’s manual. Additional instructions for front end service of the VIPER 4 tool can also be found in the Operator’s Manual.



VIPER 4 Front End Disassembly



1. Unscrew the Retention Collar and pull back on the Collar exposing the two Pawls as shown in the picture.

An extremely dirty tool may require the use of an adjustable pin style spanner wrench to assist with removal of the collar.

The wrench shown is Williams part number 0-471A with a pin diameter of 3/16"



2. Remove the two pawls, one from each side. Pull barrel assembly from body of tool.

Note the position of the two pawls. The narrow end of the pawls should have squared off corners. Any large chips or breakage would indicate the need to replace the pawl.



3. Once the Barrel is removed unscrew the Muzzle; a 19mm or 3/4-inch open end wrench can be used on the wrench flats to assist in muzzle removal. Remove piston and remaining parts as shown.





4. Inspect the front end components. Check the piston is straight and free of chipping on the fastener striking end.



5. Clean the front end components with a wire brush. Ramset part number PATCK contains a variety of wire brushes to assist with cleaning the Viper tool and a variety of other powder actuated tools.



6. Industrial spray solvents or automotive brake cleaners that are safe for plastic can be used to remove other oils and debris.

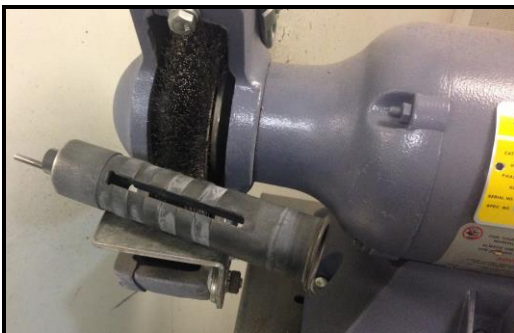

7. To speed up the cleaning process, a wire wheel mounted to a bench grinder can be used to clean the outer surfaces.



8. A round, wire tube brush can be chucked into a drill to clean the inner surfaces; i.e. inside of the barrel, inside of the receiver, etc.

The use of any lubricant on reassembly is not recommended.

Should the tool sit un-used for a long period of time, an oil can be used on the outer surfaces of the metal parts provided the parts are wiped dry before reassembly.

Excess oil or lubricants will attract powder residue and increase maintenance frequencies.



9. To reassemble, place the piston into the barrel. Piston should be pushed all the way to the back of the barrel.



10. Insert the buffer into the end of the muzzle as shown and screw into barrel.



11. Place the spring over the end of the barrel and position front retention collar as shown.



12. Insert barrel back into tool housing, aligning pawl slots. Insert the pawls on each side. Front end should close, if not rotate the barrel so the cocking rod is on the opposite side, keeping the pawl slots aligned. Front end parts need only to be hand tightened.

Should the Viper 4 experience problems with load advancement, the following steps will guide you through replacing the advance lever, and the advance pin holder assembly.

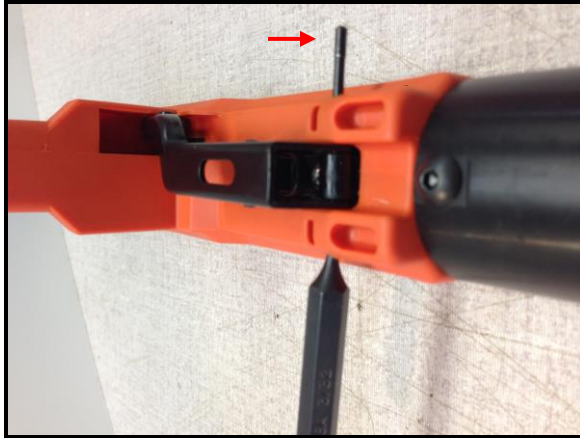

1. Tap out the advance lever pin using a 3/32 drift pin punch. Tap the advance pin all the way to one side but do not remove. Upon removing the drift pin punch, the round black plastic advance pin spacer will fall from the tool.



2. Remove Advance Pin Holder screw under the advance lever. Using a 3mm Hex Plus Hex Key wrench, insert end into the slot in the advance lever.

This can be a troublesome screw. In some tools the screw is held in place with a thread-locking compound. On other tools this screw may be loose or has fallen out.



3. Lift out the assembly. Shown to the left is the advance lever, the Advance Pin Holder Assembly. Twist the Advance Pin Holder to remove it from the advance lever.

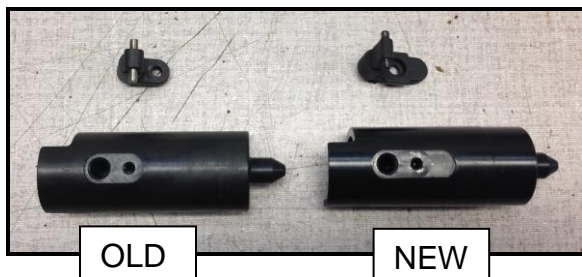
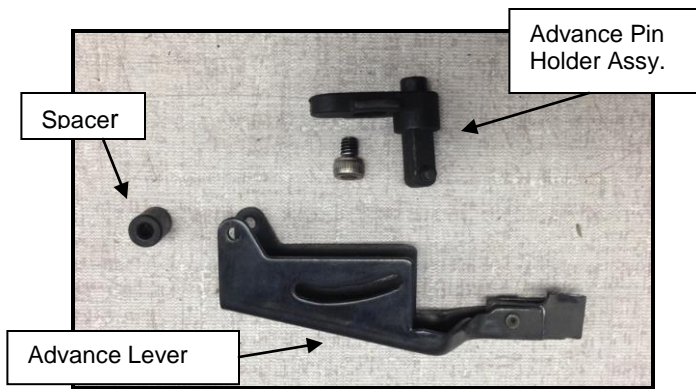

4. The picture to the left shows the disassembled Advance Lever, Advance Pin Holder, Advance Pin Holder Screw and the round black Advance Lever Pin spacer
5. To begin reassembly, clean and inspect components. Be certain female threads in the trigger sleeve in the body of the tool are clean. The mating Advance Pin Holder screw should also be clean. A cotton swab can be used to clean the female threads in the trigger sleeve (see arrow)
6. If replacing the Advance Pin Holder Assembly (P/N 100309A), note that there are variations to the part and mating Trigger Sleeve (P/N 100298). The OLD style Advance Pin Holder is shorter in length, as is the corresponding counter bore slot in the trigger sleeve. A NEW longer style Advance Pin Holder Assembly cannot be used with an OLD style trigger sleeve due to the shorter counter bore slot.

Do not mix up advance pin holder screws. The old style uses a longer screw, while the new style uses a shorter screw.

Newer parts can be used in older tools, provided the all newer matching parts are used. This may also provide additional reliability to the tool.

7. Assemble Advance Pin Holder and Advance Lever as shown. The pins should ride in the slots of the advance lever.



8. Align the Trigger Sleeve in the tool housing to accept the Advance Pin Holder. You may have to apply some pressure to the center plunger inside the Ball Retainer/Rear Collar to align the part for assembly. In some cases it might be easier to remove the Ball Retainer/Rear Collar and apply pressure to the trigger sleeve to install the Advance Pin Holder and Advance Lever assembly.
9. Apply a small amount of Red Loctite 2760 to the Advance Pin Holder Screw. Then install the Advance Pin Holder and Advance Lever Assembly. Be certain to tighten the screw before doing anything with the Advance Lever Pivot Pin.
10. Insert the 3/32 Drift Pin Punch through the open end hole in the housing, using the drift pin punch to align the hole in the housing, the hole in the Advance Lever, and the round black Advance Pin Spacer. Once you have the parts aligned, tap the Advance Lever Pivot Pin into position. Be certain the Advance Lever Pivot Pin is centered, equal engagement into the holes in the orange housing.
11. If you removed the Ball Retainer/Rear Collar assembly, be certain the ball is placed in the Ball Retainer and moves freely. Thread the Ball Retainer/Rear Collar back onto tool. Turn until tight, then back off slightly until the Rear Collar Retention Screw can be installed.

A problem in the firing mechanism will result in the tool failing to fire, or failure of the firing pin to release. It is possible for the firing mechanism to be working properly and misfires to occur. Therefore it is important to be able to identify the problem prior to any corrective actions. Some of these problems could be associated with the user not fully compressing the tool before it is fired. Diagnose the tool by removing all pin and loads and dry firing the tool several times. A distinct “click” should be heard. If it has been determined that the firing mechanism is at fault, the steps below will guide you through the disassembly and assembly of the firing mechanism.

Begin by following the steps in the previous chapter to remove the Front End



1. Remove the rear collar retention screw using a 3mm hex wrench.

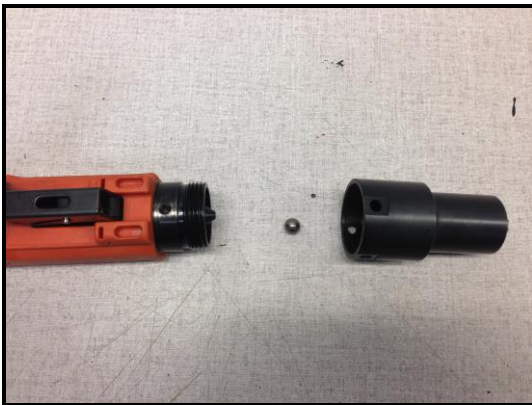

2. Once the retention screw is removed, unscrew the rear collar. Use caution when removing the collar as the stop ball rolls freely inside this part. The stop ball is a 9mm ball bearing.



3. Remove the advance lever. Tap the pin out using a 3/32” drift pin punch. Tap pin through, but not all the way out. After removing the drift pin, there is a plastic spacer that will fall from the tool.



4. Remove the screw under the advance lever. This can be a troublesome screw. In some tools the screw can be loose, others maybe held tight with a threadlock compound. The use of a 3mm Hex Plus T-handle wrench will help in removal. .



5. Once the Advance Lever assembly and Advance Pin holder is removed, locate and remove the bottom screw at the front end of the tool, 3mm Hex Key Wrench. The wrench size may vary depending on age of the tool.



6. Turn the tool over and locate the warning label at the top rear of the tool. On early versions of the Viper 4, there is a screw underneath this label which retains the trigger sleeve. Carefully cut the label, or pierce the label with a 3mm Hex Key wrench in the position shown, locate and remove the screw. Slide the trigger sleeve out from the rear of the tool.

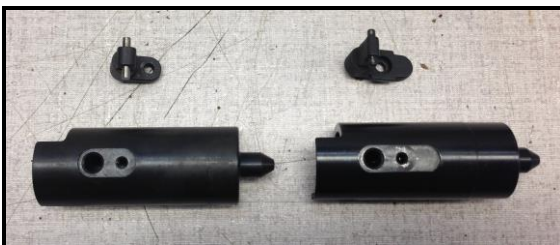

7. The next two photos show the view from under the label. The photo with the slot and screw is the older model. Remove the screw under the label. This screw holds the Trigger Sleeve in the tool.

On newer versions, the design of the trigger sleeve was changed and the screw was no longer necessary. On newer versions the Trigger Sleeve will slide out of the back after removing the Advance Pin Holder.

Should the warning label cover be destroyed during service, replacements are available from ITW Service and Parts.

8. Trigger Sleeve shown removed from tool. Note the spring that resides inside.

9. Very early versions of the Viper 4 tool used a Trigger Sleeve with a smaller Advance Pin Holder, depicted to the far left. These early components do not interchange with later versions.

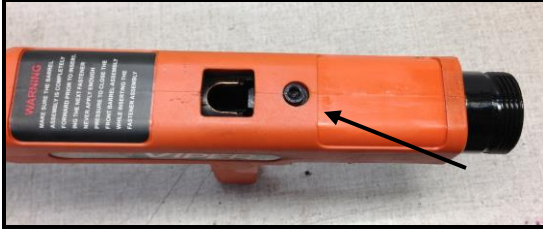

10. Next remove the screw at the top of the tool near where the strip load comes through. Use a 4mm hex key wrench to remove the screw.



11. To properly service the firing pin, the receiver must be removed from the tool.

Insert the end of a small hammer handle or block of wood into the back end of the tool. Tap the tool body on to the end of the hammer handle as shown. This will begin to push the metal receiver up and eventually out the front end of the plastic tool housing.

The rear threaded portion stays with the plastic housing and does not need to be removed.

The front threaded portion where the pawls sit will come up and out with the tapping motion. The receiver has a slight press fit into the plastic housing. It does take some effort to remove.



12. Shown to the left is the receiver coming out of the front of the plastic housing. Once you get close to the area where the strip load goes through the receiver, there are two springs and detent balls that will come out. Be prepared as the springs are under light pressure and can be easily lost.

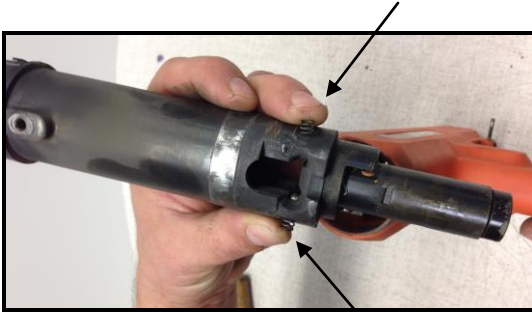

13. The location of the detent balls and springs are shown. As the receiver comes out of the housing grab the area at three-o'clock and nine-o'clock to hold on to the springs



14. Should the balls and springs fly out, they can be replaced using part number MVP001A. This is the same part used in the prior Viper III model. Be certain to clean the counter bore area where the ball and spring sit on each side.



15. Unscrew the Firing Pin Spring Plug from the rear tube area of the receiver. Note the Firing Pin Spring behind the plug.

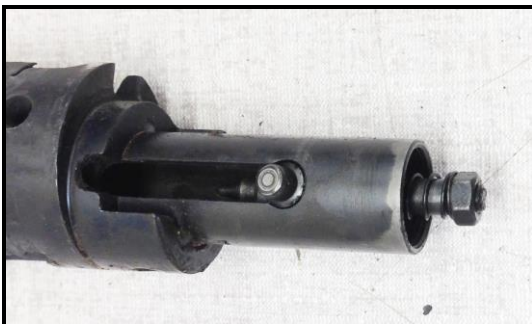

16. Slide the firing pin back toward the round hole at the end of the slot. The Firing Pin Sear must be removed before the Firing Pin can be removed from the housing



17. Remove the firing pin sear. There is a spring below the firing pin sear. You may need to push the sear down and slightly move the assembly to work it out of the firing pin and up through the round hole at the end of the slot in the tube shaped area of the receiver. Once the sear is removed the Firing Pin will slide out of the end of the tube.



18. The receiver disassembled is shown to the left.



19. Note the threaded portion at the rear of the plastic housing is left with the housing. There is no need to remove this.

The tool should be completely disassembled at this point.

Each component should be cleaned and inspected prior to reassembly.



20. There are a variety of cleaning materials and methods available in the marketplace. Shown to the left is a sample of some of the industrial spray cleaners that can be used to clean the tool.

The brushes shown are used to get some of the more baked on debris from the inner and outer surfaces of the metal parts.

Part number PATCK is a kit available from the ITW Service Parts group containing many of the necessary brushes needed to clean the Viper and other powder actuated tools.



Part No. PATCK
Cleaning Kit
Qty: 1



21. A wire wheel on a bench grinder is a quick way to thoroughly clean the outside of the various larger metal parts, i.e. receiver, barrel, piston.

Use caution when using any power tool. Follow the manufacturer's instructions on tool use.



22. A wire tube brush is used to clean the inside diameters of the various ends of the receiver, barrel and muzzle.

Besides the tube brushes in the PATCK kit, other diameters and sizes can be found at various retailers selling MRO supplies.



To speed up the cleaning process, the looped end of the tube brush can be cut off and chucked inside a cordless drill.



23. Using a small flat blade screw driver, be sure to scrape the residue from the tracks where the strip load comes through the receiver.

Excess debris in this area can cause strip load advance issues.

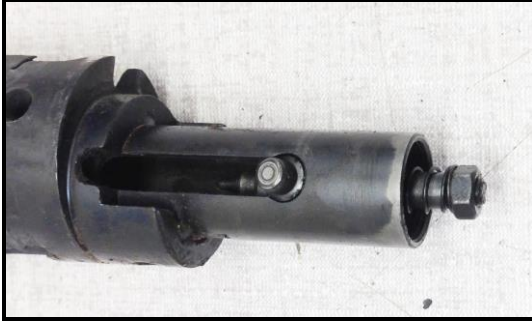

24. Begin to reassemble tool.

Insert the firing pin into the end of the tube section. Align sear hole in firing pin with larger hole at the end of the slot in tube section. Insert the sear spring, then the narrow end of sear into firing pin. Push down on sear and slide assembly down the tube.

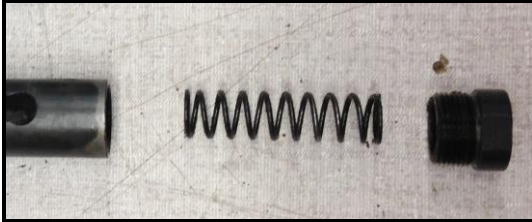

25. Insert firing pin spring, and then thread Firing Pin Spring Plug on to end of tube. Tighten with a 17mm wrench.



26. Find Detent Liner Balls and springs. Insert the ball then spring into the hole on each side of the receiver.

Be certain the holes are clean before inserting the components.

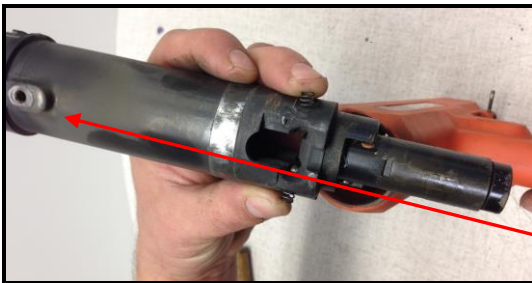

27. Hold and compress the two springs on the receiver.

Note the position of the receiver in relation to the housing. The screw boss at the bottom of the receiver should align with the pocket in the plastic housing



28. Hold onto the Liner Balls and springs and properly insert the receiver into the housing.

Tap the receiver into the housing with a block of wood.



29. Fine tune the alignment of the Receiver and the Housing to be able to install the screw holding the Housing to the Receiver.

Align and start the bottom screw. Then before completely tightening, find the top screw pictured below and be certain you are able to insert the screw

Tighten the bottom screw with a 3mm hex key.

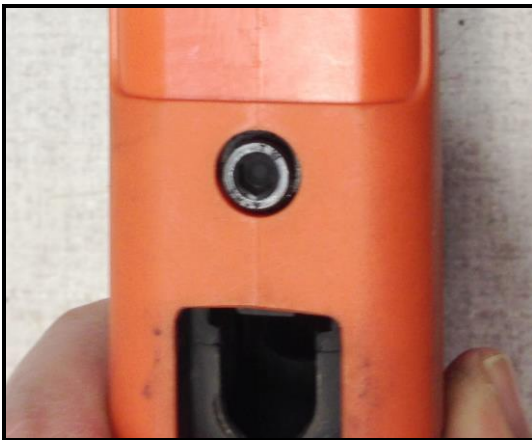

30. Install the top screw. Apply Loctite at minimum "blue version" to this screw and tighten with a 4mm hex key.

31. Locate the Trigger Sleeve and Trigger Sleeve Spring.

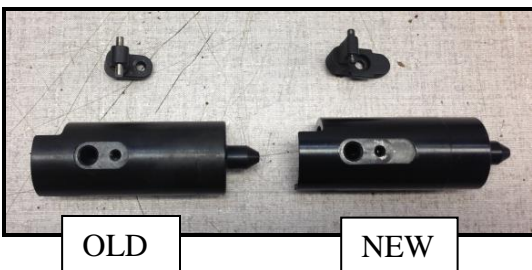

Note the picture on the left. Very early versions of the Viper 4 tool used the trigger sleeve and Advance pin Holder on the left side. Later models used the version on the right. The difference is in the length of the counterbore area. New styles used the longer counterbore. New parts can go into older tools, but old style parts cannot go in newer tools.

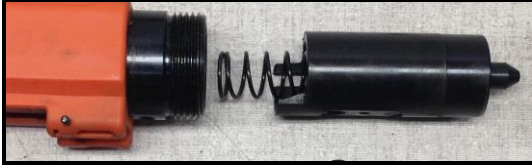

32. Insert Trigger Sleeve Spring into Trigger Sleeve at shown and insert assembly into back end of tool.

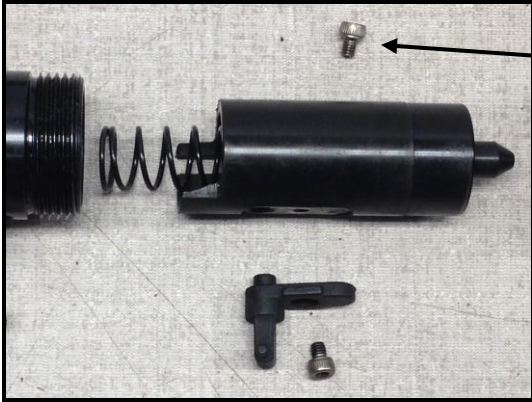

33. Some older versions of the Viper 4 used a screw at the top of the Trigger Sleeve. This screw is inserted through a slot at the top of the housing. Newer versions did not use this screw at the top.



34. Note the differences in the housings. Older style used the slot under the warning label, while later revisions the screw and slot were removed.



Consideration should be given to using the new style Trigger Sleeve and Advance Pin Holder as this will increase reliability. These new parts can be used with an older style housing with slot.



35. Note the differences in the Advance Pin Holder assembly. The part in the far right of the picture is the latest design revision.



36. There is a difference in screw length used to hold the Advance Pin Holder. The newer revisions use a shorter screw length. **DO NOT MIX SCREW LENGTHS**



37. Align Trigger Sleeve in housing so holes are oriented as in the photo to the left.



38. Locate the Advance Lever and Advance Pin Holder assembly. Hook the Advance Pin Holder assembly into the Advance lever as shown.



39. Use Loctite 2760 (red) on the Advance Pin Holder screw.

The use of any other Loctite “colors” on this screw may lead to the screw coming loose.

Be certain screw threads are clean, dry, and free of oil. Also be certain the mating female threads in the Trigger Sleeve are clean, dry and free of oil as well.

Apply a small amount of Loctite to the male thread. Too much Loctite may cause the excess product to seep into tool binding up other components.

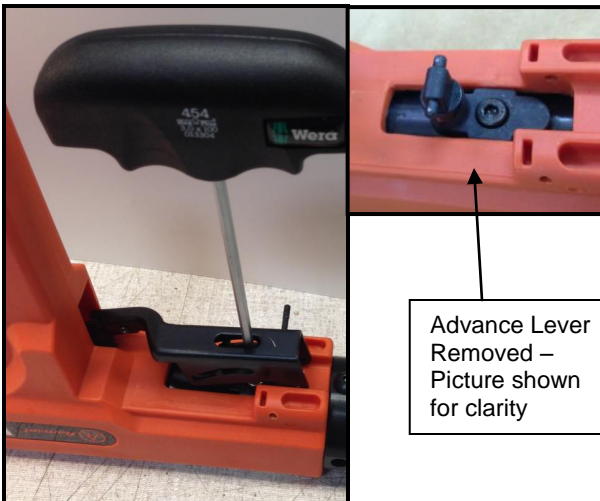

40. Place assembly onto tool, insert 3mm hex key wrench and slowly tighten screw. It may help to apply pressure to the back of the trigger sleeve in order to start the screw thread.

Advance Lever Removed – Picture shown for clarity



41. Insert 3/32" Drift Pin Punch into orange housing and through the hole in the advance lever. Insert the black round plastic spacer. Push pin punch through center hole.

The drift pin will align the holes in the various parts for the next step of driving the roll pin through.

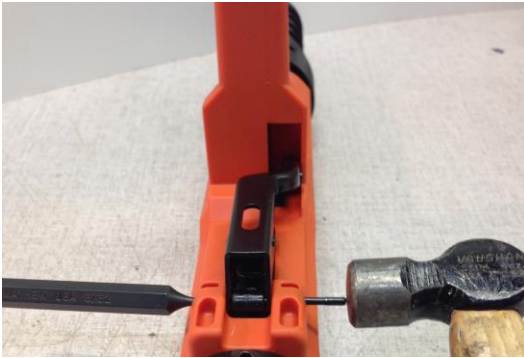

42. Using a small hammer, drive the roll pin through the advance lever components. As you tap the roll pin through, the drift pin punch will maintain alignments and back out. Center the roll pin equally in the orange housing.

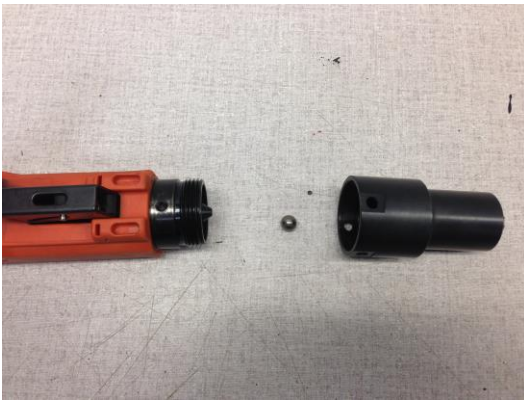

43. Locate the Rear Collar/Ball Retainer and the Stop Ball. Place the Stop Ball (9mm bearing) into the Rear Collar/Ball Retainer and thread on to housing.

Later versions of the Viper 4 have increased spring pressure in the Rear Collar Ball retainer. This increased spring pressure improves function when using the 3-foot pole tool, P/N: V4-3



44. Tighten Rear Collar/Ball Retainer on to housing. Back off slightly to align hole in Rear collar with hole in housing. Insert the retaining screw and tighten with a 3mm hex key wrench.



45. The backend of the tool should now be completely assembled, as the picture shows.

Follow the prior chapter 3a to reassemble the front end of the tool.

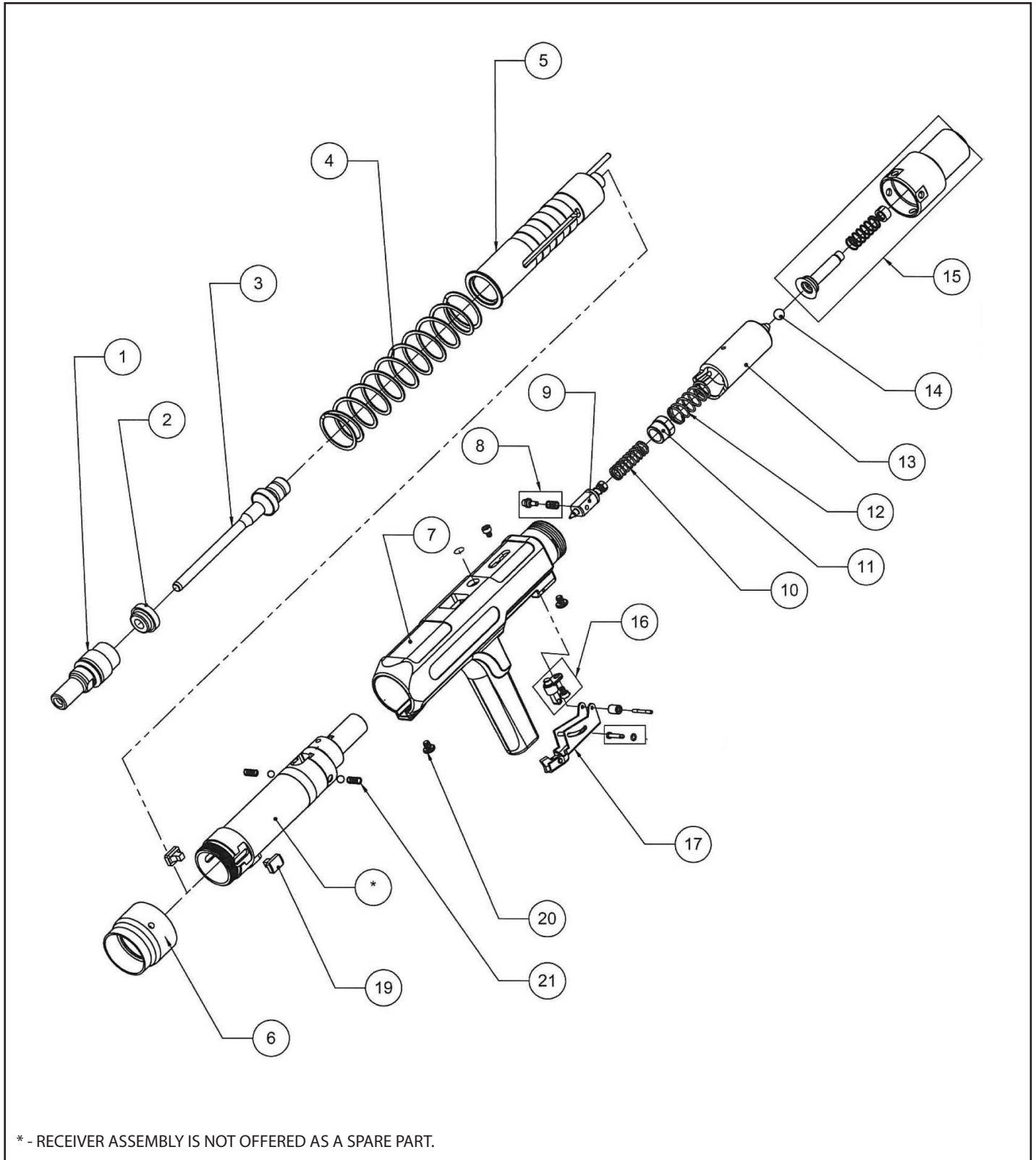

KEY	PART NO.	DESCRIPTION
1	100306	MUZZLE BUSHING
2	MVP110A	BUFFER (PKG. OF 3)
3	MVP140	PISTON
4	100308	RETURN SPRING
5	100290	BARREL ASSEMBLY
6	100307	RETENTION COLLAR
7	100295A	HOUSING ASSEMBLY
8	100292A	FIRING PIN SEAR & SPRING
9	100291	FIRING PIN ASSEMBLY
10	100293	FIRING PIN SPRING
11	100294	FIRING PIN SPRING PLUG
12	100302	TRIGGER SLEEVE SPRING
13	100298	TRIGGER SLEEVE
14	100313	STOP BALL
15	100310A	BALL RETAINER/COLLAR ASSEMBLY
16	100309A	ADVANCE PIN HOLDER ASSEMBLY
17	100300A	ADVANCE LEVER ASSEMBLY WITH PIN
19	316540	PAWLS (PKG. OF 2)
20	100299A	SCREWS (PKG. OF 5)
21	MVP001A	LINER BALLS & SPRINGS

VIPER 4 TOOL MUST USE RAMSET V4 SERIES POLE TOOLS!